

SNOW BLADES

REACTOR

— AVAILABLE WITH —

FLUIDEDGE



www.amiattachments.com





IMPROVED FLUID EDGE SYSTEM

- Upgraded to **HARDOX® 500**
- Updated Edge System (see details below)



WATCH IT IN ACTION



YouTube /AMIATTACHMENTS



TRACKING EVERY MOVEMENT FOR A CONSISTENT, CLEANER PASS

Gain the upper edge and improve your snowplowing capabilities this winter with the all-new FluidEdge Segmented Cutting Edge. Featuring individual 12" segments that respond and conform to uneven surfaces, FluidEdge provides exceptional snow clearing no matter what conditions winter throws at you.

With minimal moving parts - only a Hardox 500 cutting edge and a rubber suspension block - FluidEdge boasts a simple design that is also easy to service and maintain. Requiring only two bolts and two nuts, replacing a FluidEdge segment is an easy one-person job. Because you don't need to replace the entire blade, FluidEdge is also an economical solution to lowering costs for your snowplowing fleet.

SAVE THE SALT & ENVIRONMENT

FluidEdge significantly reduces salt requirements because less snow and ice remain after plowing. Less salt is often a competitive advantage and reduces the environmental impact of your operations.

With this new system the retainer plate sits right up against the cutting edge assembly itself. The retainer plate, bolts and cutting edge travel up and down together as one assembly in the slotted holes in the trip edge assembly. The top of the FluidEdge GN2 is closed (sealed) to prevent material from falling behind the edge.

RUBBER SUSPENSION BLOCK REDUCES VIBRATION	12-INCH SEGMENTS FOLLOWS THE SURFACE	HARDOX 500 LONG LASTING CUTTING EDGE
---	--	--

BUMPS



RUTS



5° TILT



RIDGES



POTHOLES



1.5" VERTICAL TRAVEL



REACTOR

4-IN-1 ANGLE BLADE

AVAILABLE WITH
FLUIDEDGE



6' - 20' Widths
11' - 30' Widths



BOX BLADE



REVERSE BOX BLADE



ANGLE BLADE



STRAIGHT BLADE

4-IN-1 ANGLE BLADE

The big 4-in-1 Angle Blade for wheel loaders, loader backhoes, skid steers and telehandlers is a system of four blade positions that give you the tools to clear large areas of snow fast.

The endplates are hydraulically-controlled and equipped with industry-proven rotary actuators, giving you rugged and limitless control within the massive 180 degree rotation. Getting close to buildings and other objects is easy with the limitless on-the-fly in-cab adjustability.

When the big storm hits and you need to react fast - count on the AMI Reactor 4-in-1 Angle Blade to get the job done in style.

PRODUCT FEATURES

*Optional for 400/500/600 models (not available for 300)

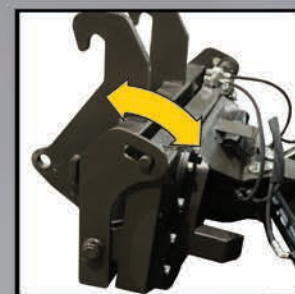

*Optional Forward Float

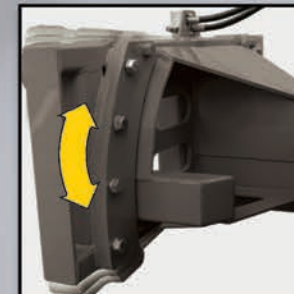

Lateral Float

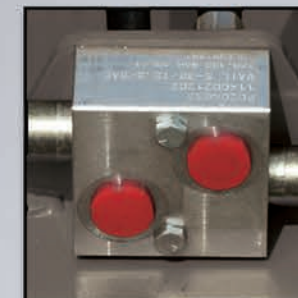

Cross-Over Relief Valve Protection



Spring-Trip Cutting Edge

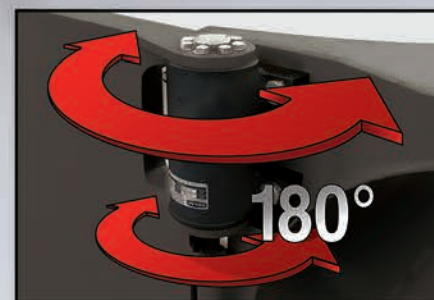

180° Pivot Range Rotary Actuator



Tire Protection System



Moldboard Design Promotes Efficient Rolling of Snow Optional Spill Guard



- 6' - 20' Closed Width, 11' - 30' Open Width
- 30" - 53" High Moldboard
- Quick Coupler or Direct Loader Attach
- Spring-Trip Cut Edge, Reversible, Replaceable
- High Tensile Long Skidding Shoes
- Relief Valve on all Cylinders
- Floating Edge on Endplates
- Forward and Lateral Float
- Actuator has 38,700 in-lbs. Torque at 3000psi
- 180° Endplates: 30" - 60" Widths
- 2-Year Limited Warranty Included

REACTOR

4-IN-1 ANGLE BLADE AVAILABLE WITH FLUIDEDGE



4-IN-1 ANGLE BLADE (5 FT. WING)

For maximum plowing versatility, the 4205, 5205 and 6205 4-in-1 models allow for greater clearing capacity at large sites, with the flexibility to handle a smaller plowing area by narrowing down the blades. The endplates are hydraulically-controlled and equipped with industry-proven rotary actuators, giving you rugged and limitless control within the massive 180 degree rotation. Getting close to buildings and other objects is easy with the limitless on-the-fly in-cab adjustability.

- 5' Wings
- Removable Upper Wing Tip
- 180° Rotation
- Crossover Relief Valve
- Floating End Plate Edge
- Lateral Float
- Nitrate Rods on Angle Cylinders
- Replaceable, Reversible Cutting Edge
- Rotary Actuators
- Skid Shoes
- Spring Trip Cutting Edge
- Tire Protection System
- 2-Year Limited Warranty Included

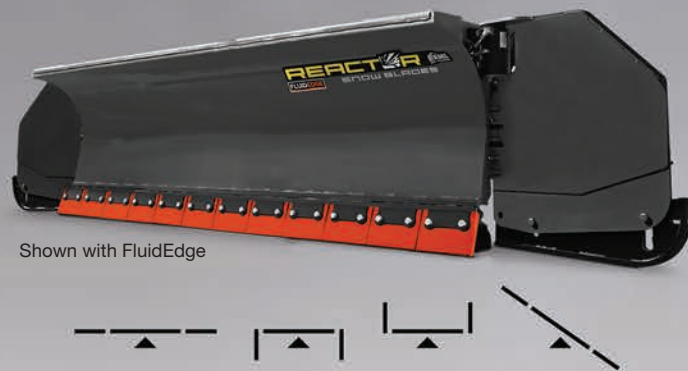

4-IN-1 ANGLE BLADE 3200

WHEEL LOADER 1 - 1.5 CU. YDS CAPACITY
SKID STEER

Model	FLUIDEDGE	Width Closed	Width Open	Road Width Angled	Width Angled	Moldboard Height	Weight (lbs)
SB320611	No	6'	11'	5' 9.9"	8' 11"	30"	1570
SB320611FE	Yes	6'	11'	5' 9.9"	8' 11"	30"	1570
SB320712	No	7'	12'	6' 8"	9' 9"	30"	1640
SB320712FE	Yes	7'	12'	6' 8"	9' 9"	30"	1640
SB320813	No	8'	13'	7' 6"	10' 7"	30"	1700
SB320813FE	Yes	8'	13'	7' 6"	10' 7"	30"	1700
SB320914	No	9'	14'	8' 4"	11' 5"	30"	1765
SB320914FE	Yes	9'	14'	8' 4"	11' 5"	30"	1765
SB321015	No	10'	15'	9' 2"	12' 3"	30"	1830
SB321015FE	Yes	10'	15'	9' 2"	12' 3"	30"	1830

4-IN-1 ANGLE BLADE 4200

WHEEL LOADER 1.5 - 2.5 CU. YDS CAPACITY
LOADER BACKHOE

Model	FLUIDEDGE	Width Closed	Width Open	Road Width Angled	Width Angled	Moldboard Height	Weight (lbs)
SB4230814	No	7' 9.5"	13' 9.5"	7' 8"	11' 4"	34"	2720
SB4230814FE	Yes	7' 9.5"	13' 9.5"	7' 8"	11' 4"	34"	2720
SB4230915	No	9'	15'	8' 6"	12' 2"	34"	2880
SB4230915FE	Yes	9'	15'	8' 6"	12' 2"	34"	2880
SB4231016	No	10'	16'	9' 4"	13'	34"	2985
SB4231016FE	Yes	10'	16'	9' 4"	13'	34"	2985
SB4231218	No	12'	18'	11'	14' 8"	34"	3185
SB4231218FE	Yes	12'	18'	11'	14' 8"	34"	3185
SB4231420	No	14'	20'	12' 9"	16' 4"	34"	3440
SB4231420FE	Yes	14'	20'	12' 9"	16' 4"	34"	3440

4-IN-1 ANGLE BLADE 5200

WHEEL LOADER 2.75 - 3.5 CU. YDS CAPACITY

Model	FLUIDEDGE	Width Closed	Width Open	Road Width Angled	Width Angled	Moldboard Height	Weight (lbs)
SB5230915	No	9'	15'	8' 7"	12' 2"	42"	3455
SB5230915FE	Yes	9'	15'	8' 7"	12' 2"	42"	3455
SB5231016	No	10'	16'	9' 5"	13'	42"	3620
SB5231016FE	Yes	10'	16'	9' 5"	13'	42"	3620
SB5231218	No	12'	18'	11' 1"	14' 8"	42"	3875
SB5231218FE	Yes	12'	18'	11' 1"	14' 8"	42"	3875
SB5231420	No	14'	20'	12' 9"	16' 4"	42"	4170
SB5231420FE	Yes	14'	20'	12' 9"	16' 4"	42"	4170
SB5231622	No	16'	22'	14' 5"	18'	42"	4490
SB5231622FE	Yes	16'	22'	14' 5"	18'	42"	4490



4-IN-1 ANGLE BLADE (5 FT. WING) 5205

WHEEL LOADER 2.75 - 3.5 CU. YDS CAPACITY

Model	FLUIDEDGE	Width Closed	Width Open	Road Width Angled	Width Angled	Moldboard Height	Weight (lbs)
SB5250919	No	9'	19'	8' 7"	15' 9"	42"	4115
SB5250919FE	Yes	9'	19'	8' 7"	15' 9"	42"	4115
SB5251020	No	10'	20'	9' 5"	16' 7"	42"	4245
SB5251020FE	Yes	10'	20'	9' 5"	16' 7"	42"	4245
SB5251222	No	12'	22'	11'	18' 3"	42"	4510
SB5251222FE	Yes	12'	22'	11'	18' 3"	42"	4510
SB5251424	No	14'	24'	12' 9"	19' 11"	42"	4800
SB5251424FE	Yes	14'	24'	12' 9"	19' 11"	42"	4800
SB5251626	No	16'	26'	14' 5"	21' 7"	42"	5120
SB5251626FE	Yes	16'	26'	14' 5"	21' 7"	42"	5120

4-IN-1 ANGLE BLADE (5 FT. WING) 4205

WHEEL LOADER 1.5 - 2.5 CU. YDS CAPACITY
LOADER BACKHOE

Model	FLUIDEDGE	Width Closed	Width Open	Road Width Angled	Width Angled	Moldboard Height	Weight (lbs)
SB4250818	No	7' 9.5"	17' 9.5"	7' 7"	13' 4"	34"	3290
SB4250818FE	Yes	7' 9.5"	17' 9.5"	7' 7"	13' 4"	34"	3290
SB4250919	No	9'	19'	8' 6"	14' 3"	34"	3435
SB4250919FE	Yes	9'	19'	8' 6"	14' 3"	34"	3435
SB4251020	No	10'	20'	9' 4"	15' 1"	34"	3550
SB4251020FE	Yes	10'	20'	9' 4"	15' 1"	34"	3550
SB4251222	No	12'	22'	11'	16' 9"	34"	3745
SB4251222FE	Yes	12'	22'	11'	16' 9"	34"	3745
SB4251424	No	14'	24'	12' 8"	18' 5"	34"	4035
SB4251424FE	Yes	14'	24'	12' 8"	18' 5"	34"	4035

4-IN-1 ANGLE BLADE (5 FT. WING) 6205

WHEEL LOADER 3.25 - 6.25 CU. YDS CAPACITY

Model	FLUIDEDGE	Width Closed	Width Open	Road Width Angled	Width Angled	Moldboard Height	Weight (lbs)
SB6251020	No	10'	20'	9' 7"	16' 3"	53"	5050
SB6251020FE	Yes	10'	20'	9' 7"	16' 3"	53"	5050
SB6251222	No	12'	22'	11' 3"	17' 11"	53"	5375
SB6251222FE	Yes	12'	22'	11' 3"	17' 11"	53"	5375
SB6251424	No	14'	24'	12' 11"	19' 7"	53"	5645
SB6251424FE	Yes	14'	24'	12' 11"	19' 7"	53"	5645
SB6251626	No	16'	26'	14' 7"	21' 3"	53"	6100
SB6251626FE	Yes	16'	26'	14' 7"	21' 3"	53"	6100
SB6251828	No	18'	28'	16' 3"	22' 11"	53"	6470
SB6251828FE	Yes	18'	28'	16' 3"	22' 11"	53"	6470
SB6252030	No	20'	30'	17' 11"	24' 7"	53"	6835
SB6252030FE	Yes	20'	30'	17' 11"	24' 7"	53"	6835



ANGLE BLADE

AVAILABLE WITH
FLUIDEDGE



Experience the durability and performance of the AMI Reactor Angle Blade. Conquer your work with confidence, harnessing all the key features that make a great blade.

- 6' - 20' Widths
- 1.5' Narrower when Angled
- 70° Angle Range
- Spring-Trip Cutting Edge, Replaceable, Reversible
- Up to 53" High Moldboard
- High Tensile Skid Shoes
- Forward and Lateral Float
- Cross-Over Relief Valve
- 2-Year Limited Warranty Included

PRODUCT FEATURES



Optional Spill Guard



*Optional Forward Float

*Optional for 400/500/600 models (not available for 300)



Lateral Float



CCross-Over Relief Valve Protection



Spring-Trip Cutting Edge

ANGLE BLADE 300

WHEEL LOADER 1 - 1.5 CU. YDS CAPACITY
SKID STEER

Model	FLUIDEDGE	Width	Moldboard Height	Weight (lbs)
SB306	No	6'	30"	950
SB306FE	Yes	6'	30"	950
SB307	No	7'	30"	1010
SB307FE	Yes	7'	30"	1010
SB308	No	8'	30"	1060
SB308FE	Yes	8'	30"	1060
SB309	No	9'	30"	1110
SB309FE	Yes	9'	30"	1110
SB310	No	10'	30"	1160
SB310FE	Yes	10'	30"	1160

ANGLE BLADE 400

WHEEL LOADER 1.5 - 2.5 CU. YDS CAPACITY
LOADER BACKHOE

Model	FLUIDEDGE	Width	Moldboard Height	Weight (lbs)
SB409	No	9'	34"	1935
SB409FE	Yes	9'	34"	1935
SB410	No	10'	34"	2035
SB410FE	Yes	10'	34"	2035
SB412	No	12'	34"	2225
SB412FE	Yes	12'	34"	2225
SB414	No	14'	34"	2505
SB414FE	Yes	14'	34"	2505

ANGLE BLADE 500

WHEEL LOADER 2.75 - 3.5 CU. YDS CAPACITY

Model	FLUIDEDGE	Width	Moldboard Height	Weight (lbs)
SB509	No	9'	42"	2445
SB509FE	Yes	9'	42"	2445
SB510	No	10'	42"	2550
SB510FE	Yes	10'	42"	2550
SB512	No	12'	42"	2815
SB512FE	Yes	12'	42"	2815
SB414	No	14'	42"	3095
SB414FE	Yes	14'	42"	3095
SB516	No	16'	42"	3405
SB516FE	Yes	16'	42"	3405
SB518	No	18'	42"	3700
SB518FE	Yes	18'	42"	3700

ANGLE BLADE 600

WHEEL LOADER 3.25 - 6.25 CU. YDS CAPACITY

Model	FLUIDEDGE	Width	Moldboard Height	Weight (lbs)
SB610	No	10'	53"	3285
SB610FE	Yes	10'	53"	3285
SB612	No	12'	53"	3635
SB612FE	Yes	12'	53"	3635
SB614	No	14'	53"	3900
SB614FE	Yes	14'	53"	3900
SB616	No	16'	53"	4345
SB616FE	Yes	16'	53"	4345
SB618	No	18'	53"	4650
SB618FE	Yes	18'	53"	4650
SB620	No	20'	53"	5005
SB620FE	Yes	20'	53"	5005



3-IN-1 PUSHER BLADE

AVAILABLE WITH
FLUIDEDGE



Pile it fast and high with the AMI Reactor Pusher Blade. Simply connect the Pusher to your loader using a quick coupler and get ready to gather and push using the boxed endplates for maximum volume. With a spring-trip on the cutting edge, the AMI Reactor Pusher Blade is strong, tough and forgiving.



PRODUCT FEATURES



Spring-Trip Cutting Edge



Lateral Float



Cross-Over Relief Valve Protection

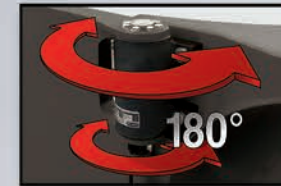

180° Pivot Range Rotary Actuator



3 Unique Blade Formations



3-IN-1 PUSHER BLADE

WHEEL LOADER 1 - 1.5 CU. YDS CAPACITY
SKID STEER

Model	FLUIDEDGE	Width Closed	Width Open	Moldboard Height	Weight (lbs)
SB320611P	No	6'	11'	30"	1449
SB320611PFE	Yes	6'	11'	30"	1449
SB320712P	No	7'	12'	30"	1515
SB320712PFE	Yes	7'	12'	30"	1515
SB320813P	No	8'	13'	30"	1574
SB320813PFE	Yes	8'	13'	30"	1574
SB320914P	No	9'	14'	30"	1628
SB320914PFE	Yes	9'	14'	30"	1628
SB321015P	No	10'	15'	30"	1688
SB321015PFE	Yes	10'	15'	30"	1688



PUSHER BLADE

AVAILABLE WITH
FLUIDEDGE



Shown with FluidEdge

Pile it fast and high with the AMI Reactor Pusher Blade.

Simply connect the Pusher to your loader using a quick coupler and get ready to gather and push using the boxed endplates for maximum volume.

With a spring-trip on the cutting edge, the AMI Reactor Pusher Blade is strong, tough and forgiving.

- 7' - 18' Widths
- Up to 42" High Moldboard
- Bucket Mount or Quick Coupler
- Spring-trip cutting edge, Reversible, Replaceable
- High Tensile Skid Shoes
- 2-Year Limited Warranty Included

PRODUCT OPTIONS

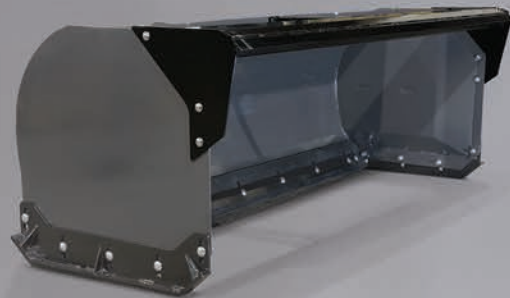

Shown with Optional Back Drag

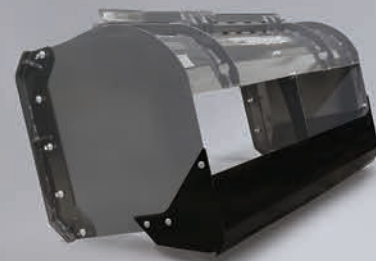

Optional Back Drag

PUSHER BLADE 300P

WHEEL LOADER 1 - 1.5 CU. CAPACITY
SKID STEER

Model	FLUIDEDGE	Width	Moldboard Height	Weight (lbs)
SB307P	No	7'	38"	990
SB307PFE	Yes			
SB308P	No	8'	38"	1060
SB308PFE	Yes			
SB309P	No	9'	38"	1100
SB309PFE	Yes			
SB310P	No	10'	38"	1175
SB310PFE	Yes			
SB312P	No	12'	38"	1350
SB312PFE	Yes			

PUSHER BLADE 400P

WHEEL LOADER 1.5 - 2.5 CU. YDS CAPACITY
LOADER BACKHOE

Model	FLUIDEDGE	Width	Moldboard Height	Weight (lbs)
SB410P	No	10'	34"	2075
SB410PFE	Yes			
SB412P	No	12'	34"	2265
SB412PFE	Yes			
SB414P	No	14'	34"	2460
SB414PFE	Yes			

PUSHER BLADE 500P

WHEEL LOADER 1.75 - 3.5 CU. YDS CAPACITY

Model	FLUIDEDGE	Width	Moldboard Height	Weight (lbs)
SB512P	No	12'	42"	2905
SB512PFE	Yes			
SB514P	No	14'	42"	3125
SB514PFE	Yes			
SB516P	No	16'	42"	3360
SB516PFE	Yes			
SB518P	No	18'	42"	3795
SB518PFE	Yes			

DOZER BLADE

The AMI dozer blade's heavy-duty design provides 30-degree angle adjustment, 10-degree side-tilt and is available in widths from 12'-16'. Optional bolt-on width extensions, high-volume endplates and height extensions also available.

2-Year Limited Warranty Included

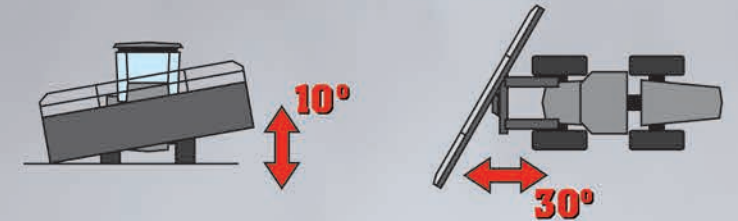
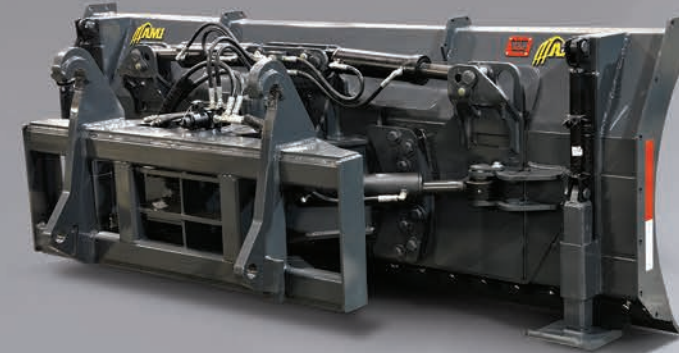

Optional

10 degrees side tilt ensures constant blade contact on slopes.

6-WAY BLADE

Perfect for clearing sidewalks, the AMI Six-Way blade features exceptional versatility. Both sides of the Six-Way blade can be adjusted to form an angle blade, scoop or V-blade, making it incredibly flexible for any type of plowing condition.

With spring-trip cutting edges that spring back when the blade strikes an obstacle, the Six-Way blade prevents unnecessary damage to both the blade and the equipment. The Six-Way blade comes standard with replaceable and reversible cutting edges for additional durability and a longer blade life.



- Replaceable, Reversible Steel Cutting Edge
- Spring Trip Cutting Edge
- 35° Angle with Cross Over Relief Valve Protection
- Lateral Float
- Single Diverter Valve
- 5/8" AR600 Cutting Edge
- High Tensile AR400 Skid Shoes
- 2-Year Limited Warranty Included

6-WAY BLADE 300V

WHEEL LOADER

Model	Width	Moldboard Height	Weight (lbs)
SB354V	54"	30"	695
SB360V	60"	30"	720
SB366V	66"	30"	740
SB372V	72"	30"	765
SB378V	78"	30"	785
SB384V	84"	30"	805

6-WAY BLADE 400V

WHEEL LOADER
LOADER BACKHOE

Model	Width	Moldboard Height	Weight (lbs)
SB408V	8'	34"	1325
SB409V	9'	34"	1450
SB410V	10'	34"	1575
SB412V	12'	34"	1800



WING BLADE



Offering exceptional flexibility, AMI's Wing Blade features a quick coupler for independent coupling of the front angle blade. As an industry first, the quick attach on both the front angle blade and wing blade gives operators the ability to use each attachment together or individually. With a 12 ft. wide mouldboard, extendible push pole with 25" extension, and a control valve with in-cab joystick controls, this blade assembly is designed for efficient snow removal and user-friendly setup.

- Independent coupling of angle blade
- Extendible push pole with 25" extension
- 64.5" side wing clearing path (retracted)
- 87.5" side wing clearing path (fully extended)
- Control Valve with in-cab joystick controls
- 48" of level bench height
- Reversible bolt-on edge
- 2-Year Limited Warranty Included



WING BLADE CONTROLLER

For optimal precision performance, the Wing Blade's joystick control system features an ergonomic design that allows operators total control at their fingertips. Easy to use and versatile, this hand-held controller offers the functionality you need to maneuver through any type of weather.

WING BLADE

Model	Part #	Width	Intake Height	Discharge Height
Side Wing Blade	SW5103SV	10'	30"	38"
Side Wing Blade	SW5123SV	12'	30"	38"

FRONT ANGLE BLADE (COMPATIBLE WITH WING BLADE)

Model	Part #	FLUID EDGE	Width	Angled Width	Height	Weight (lbs)
SB 500 Angle Blade	SB512	No	12'	9' 8"	42"	2815
	SB512FE	Yes	12'	9' 8"	42"	2815
SB 600 Angle Blade	SB514	No	14'	11' 6"	42"	3095
	SB514FE	Yes	14'	11' 6"	42"	3095
SB 600 Angle Blade	SB612	No	12'	9' 8"	53"	3375
	SB612FE	Yes	12'	9' 8"	53"	3375
SB 600 Angle Blade	SB614	No	14'	11' 6"	53"	3640
	SB614FE	Yes	14'	11' 6"	53"	3640

MOTOR GRADER WING BLADES



FRONT MOUNTED WING BLADE



REAR MOUNTED WING BLADE

ONE WAY BLADE

With a 10 ft. clearing path and 35-degree fixed angle, this One Way Blade is built for high speed operation, clearing snow quickly and thoroughly. Features include adjustable and replaceable skid shoe, replaceable nose and bolt-on edge, right side discharge, and adjustable spring trip moldboard. For easy adjustment for uneven roads this blade offers a 20-degree oscillation on plow frame and 14-degree manual moldboard pitch adjustment. Optional hydraulic moldboard pitch adjustment is also available.



ONE WAY BLADE (COMPATIBLE WITH WING BLADE)

Model	Part #	Width	Pass Width	Intake Height	Discharge Height	Weights
SB 600 One Way Blade	SB6121W	12'	10' 2"	38"	64"	3390



HS100

BROADCAST SPREADERS

Don't let bad winter weather bring you down. Make quick work of spreading sand and salt on icy roads and walkways with the AMT QuickSand. For your Wheel Loader or Loader Backhoe, this versatile broadcast spreader is available in single and double spinner models. Made from galvanized steel, the QuickSand features hydraulic spinners and a floating agitator that prevents clumping and ensures an even distribution pattern.



HS200

- Hydraulic Spinners
- Spinner Speed Control
- Manual Flow Rate Adjustment Slider
- Floating Agitator

QUICKSAND BROADCAST SPREADER

Model	Self Loading	Capacity	Width	Height	Depth	Weight (lbs.)	Hydraulic
HS100	Yes	½ yard	48"	44"	36"	410	Yes
HS200	Yes	1-½ yard	86"	60"	42"	1,320	Yes



ROTARY SWEEPERS

Season after season, the industrial capabilities of the versatile KingSpin match the challenges of ever-changing road conditions. Ideal for snow removal on roads, parking lots, intersections and runways, the KingSpin features double direct hydraulic drives, heavy-duty swivel caster wheels and 15° hydraulic angling in either direction.



- 8', 9', 10', and 12' widths
- Double direct hydraulic drives
- Heavy-duty swivel caster wheels, 20.5x8x10, 12 ply, 6 bolt
- Hydraulic Angle 15° left/right
- Parallel linkage on mount
- Minimum requirement is 20 GPM on asphalt
- 2-Year Limited Warranty Included

KINGSPIN HYDRAULIC ROTARY SWEEPER

Model	Description
HS0832HA	8' x 32" broom, wire/poly combination
HS0932HA	9' x 32" broom, wire/poly combination
HS1032HA	10' x 32" broom, wire/poly combination
HS1232HA	12' x 32" broom, wire/poly combination



WHEEL LOADER COUPLER

AMI Attachments' OilQuick® Wheel Loader Coupler empowers operators to swiftly transition between a vast array of hydraulic and mechanical attachments directly from the cab's safety that drastically reduces downtime. With a mere press of a button, adaptability becomes your strongest asset, allowing for seamless switching of hydraulic attachments like log fork grapples, pallet forks, dozer blades, buckets and mat grapples in seconds. AMI Attachments' OilQuick® isn't just an attachment—it's a pledge to unstoppable performance.



COMPACT DESIGN



ENCLOSED LOCKING CYLINDER



DIRT GUARDS



SCREW-ON COUPLINGS



ELECTRICAL COUPLING



Authorized Dealer



1.800.556.9452

Phone: (519) 699-0387 Fax: (519) 699-0440
1270 Geddes St., Hawkesville, ON, Canada NOB 1X0

www.amiattachments.com



#amiattachments

Specifications are subject to change without notice.

REVISED JULY 2024
EEG240969 PRINTED IN CANADA